

THREE-WAY HEAT SAVER/VENTILATOR

Modulated Damper Control System Operates in Supply, Exhaust, Heat Saver and Mixed-Air Modes

Models RREH & RRES

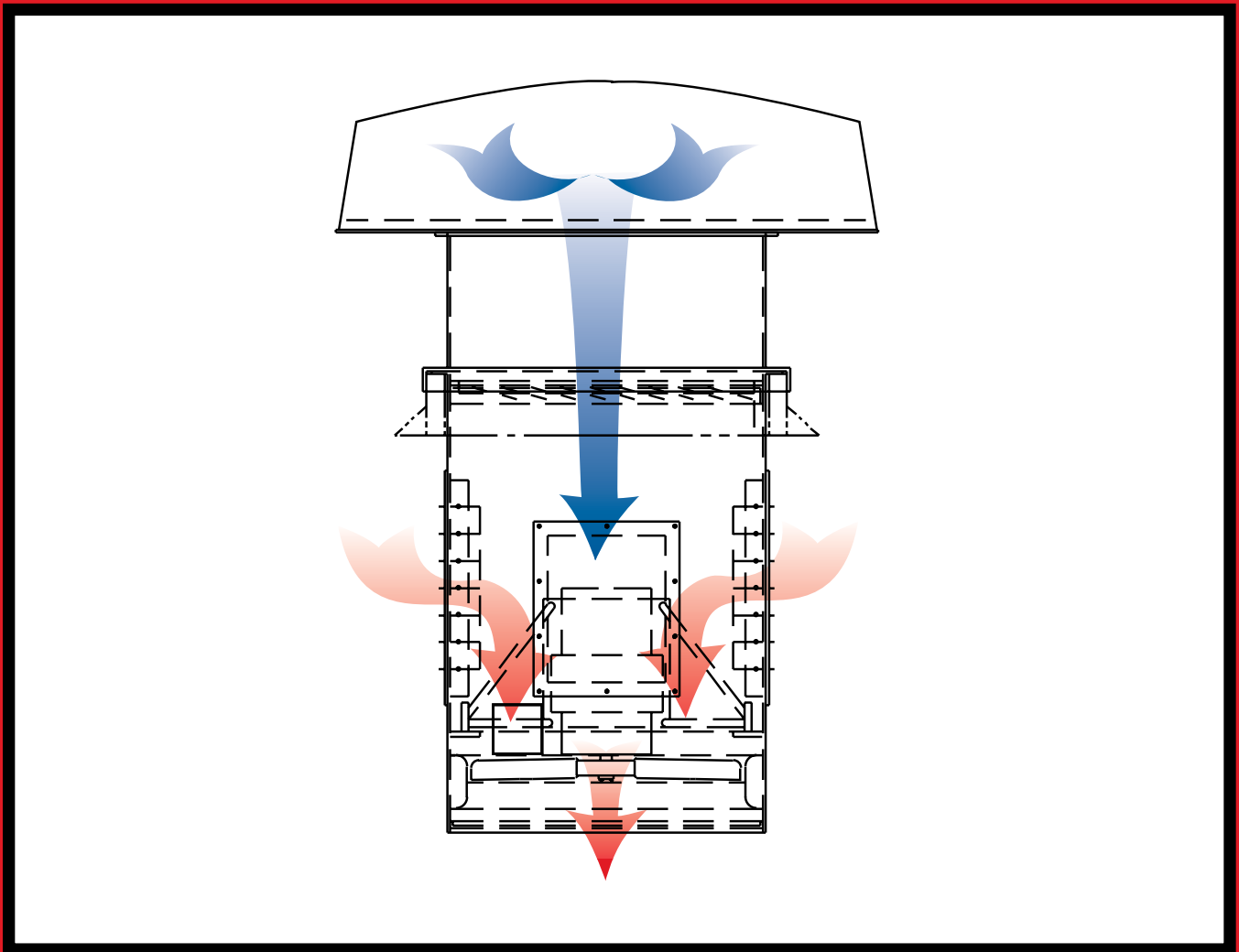

Three-Way Heat Saver/Ventilator

The Three-Way Heat Saver/Ventilator is a multi-purpose fan designed for ventilating applications that require air recirculation. Winter-time heat saving is its outstanding feature but the patented reversible fan and versatile damper control systems make a unique year-round ventilation device capable of operating in four different modes. The Three-Way Heat Saver/Ventilator can optimize its usefulness by operating in the mode that is most efficient for a given situation.

Modes

- Supply Air Mode – Supplies 100% outside air
- Exhaust Mode – Exhausts stale or hot air
- Heat Saver Mode – Recovers warm air from the ceiling and directs it back to the work area
- Mixed-Air Mode – Mixes outside air with warm in-door air and directs it to the work area

Capabilities & Features

- Sizes 24" to 60"
- Capacities to 62,000 CFM
- Pressures to 3/8" SP
- Optional construction of Aluminum, Galvanized, 304 and 316 Stainless Steel
- Optional 2-way configuration for lower first cost, less maintenance (see page 5)

Typical Three-Way Heat Saver Configuration

- Hooded inlet
- Motor operated recirculating dampers (quantity 2)
- Direct drive reversible panel fan
- Plenum section
- Prefab insulated curb (optional)
- Modulated supply damper (optional) to mix outside air with recirculated air
- Modulated temperature control (optional) to temper recirculated air with outside fresh air

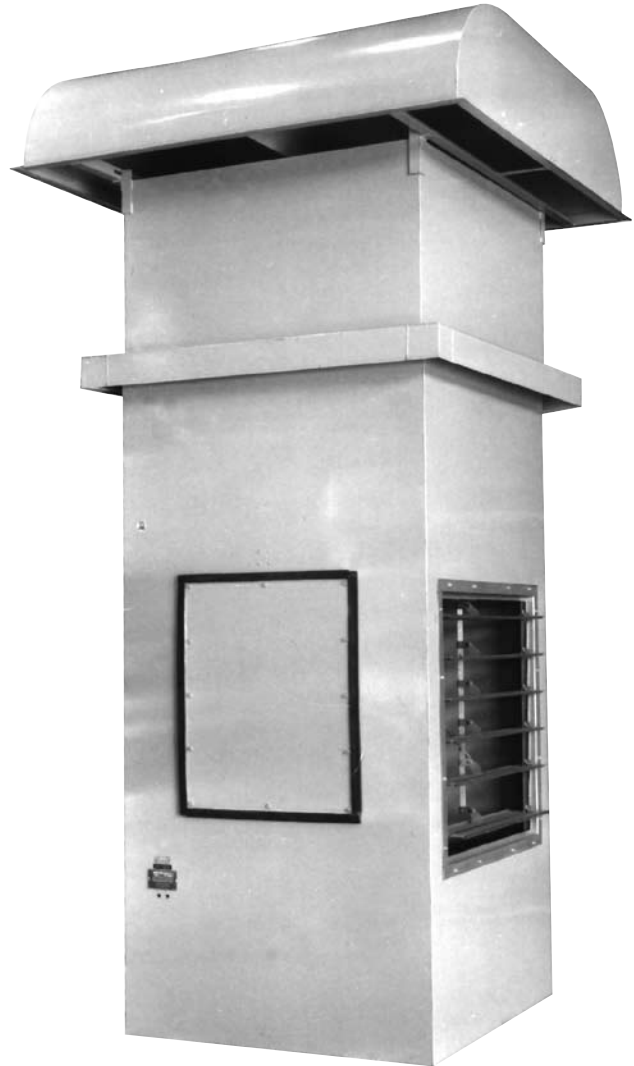

*Typical Three-Way Unit
in the Heat Saver Configuration*

The Aerovent Heat Saver/Ventilators shown herein have been tested and rated in accordance with industry-accepted test codes, and are guaranteed by Aerovent to deliver rated performance.

Three-Way Hooded Heat Saver/Ventilator (Model RREH)

Application

Buildings with high ceilings save on energy costs by using the Three-Way Heat Saver configuration. During the winter, heated air inside the building rises to the ceiling where it becomes trapped. Air temperatures near the ceiling may be 5°F to 20°F higher than temperatures at the floor in the working area. Due to convection, the heat is transferred to the exterior side of the ceiling. This causes the building to lose heat. To compensate for this heat loss and maintain a uniform temperature, the building's heating system must continually work at maximum levels.

By installing the Heat Saver unit, the warmer air at the ceiling is recovered and directed to the working area. As standard, the unit is furnished with recirculating dampers on two sides of the plenum section. The unit recirculates the air by inducing it through the recirculating dampers and directing it back to the floor level. Recirculating the heated air minimizes the transfer of heat through the building's ceiling and reduces the energy load on the building's heating system. By recycling the trapped warm air, a manufacturer can expect to save 10 to 30% on fuel bills. (See the table on page 4 for approximated temperature variations between the floor and various ceiling heights.)

In areas where high heat loads occur, the Three-Way Heat Saver/Ventilator can operate in the mixed air mode and mix the recirculated air with outside air to maintain a comfortable working environment.

Modes

Heat Saver Mode – In the heat saver mode (Figure 1), the unit induces warmer air trapped near the ceiling through the recirculating dampers and directs it downward to the working area. Recirculating the air in this way reduces the load on the heating system by maintaining a nearly uniform temperature between the floor and the ceiling.

Mixed Air Mode – The optional modulating damper control system (Figure 2) permits outside air to be added to the recirculated air. This is particularly desirable in spring and fall when wide outside temperature fluctuations can cause the heating system to override.

Exhaust Mode / Supply Mode – With the recirculating dampers closed, the unit can be used to exhaust hot air from the ceiling area (Figure 3). By reversing the fan rotation, 100% outside air can be supplied (configuration not shown). The patented reversible fan moves the same volume of air in both the supply and exhaust directions. The fan's rotation is easily switched between supply and exhaust by using the optional reversing starter.

In large rooms, it is particularly effective to use several ventilators for summertime ventilation, using alternating units as supply fans and exhaust fans. Units can then be arranged in this pattern for thorough coverage.

Figure 1. Heat Saver Mode

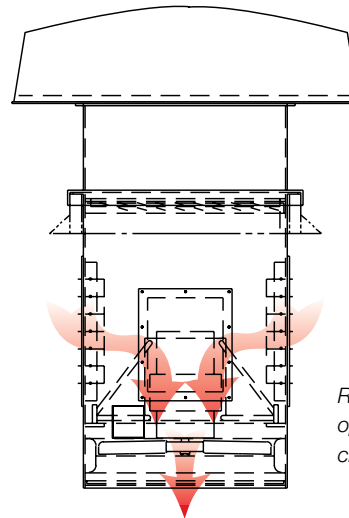

Recirculating dampers open, outside air dampers closed.

Figure 2. Mixed Air Mode

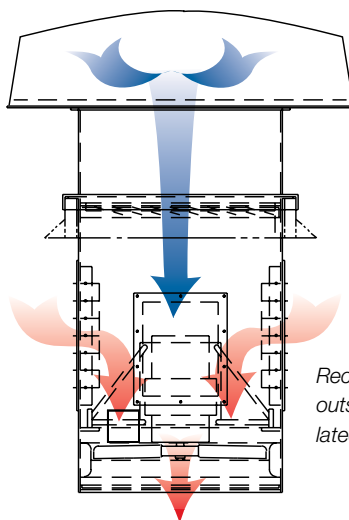

Recirculating dampers and outside air damper are modulated for proper air control.

Figure 3. Exhaust Mode

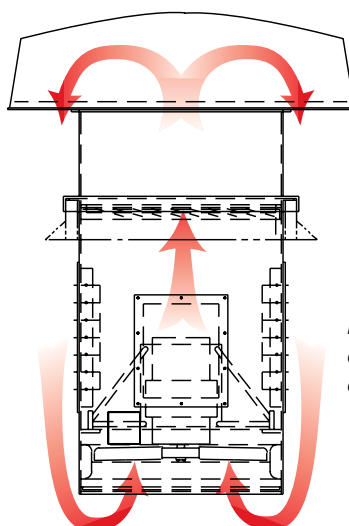

Recirculating dampers closed, outside air dampers open.

Three-Way Hooded Heat Saver/Ventilator (Model RREH)

Modulating Damper Control

An integral part of the Three-Way Heat Saver/Ventilator is Aerovent's Modulating Damper Control package. The Modulating Damper Control package is designed to modulate one supply/exhaust damper, mounted horizontally at the roof curb level, and two recirculating dampers, mounted vertically on two sides of the unit's plenum section. The three fan dampers are modulated to provide the right mix of recirculated air and outside air which reduces the heat load on the building's heating system, lowering the building's energy usage.

The Damper Control package modulates the three fan dampers by using a discharge-air temperature-sensor, controlled from a remote set point. The dampers are modulated to maintain the temperature selected on the remote station. Modulating the dampers provides the right mix of recirculated air and outside air for supply, exhaust and recirculating operations.

The control station is furnished as a separate part for remote mounting at the site. It houses the reversing starter switch for starting the fan and changing direction (reversing motor starter optional), and a temperature set point for temperature adjustments between 40° and 90°F. A mounting bracket for the discharge sensor is included for field installation at the plenum discharge. (See page 7 for the wiring diagrams, details of the control package, and adjustment and test procedures.)

Construction and Finish

Three-Way Heat Saver units are manufactured from 12-gauge continuous welded steel. Units are finished with air-dry alkyd gray enamel.

Each unit is constructed with close tolerances between the propeller tips and the orifice to maintain maximum efficiency. The patented reversible, cast aluminum alloy propeller is secured to the motor shaft with a split taper lock bushing.

The hood of the Three-Way Heat Saver/Ventilator is constructed of corrosion resistant fiberglass reinforced polyester and is attached to the fan with heavy-duty structural angle supports for added stability.

Installation

Three-Way Heat Saver/Ventilator units are designed for easy installation. The fan/damper section slides down through the roof opening until the flange at the top of the section rests on the roof curb.

When a bolt-on flange is requested, the unit can be installed from under the roof. The fan/damper section slides up through the roof opening. The flange is then bolted to the top of this section to rest on the roof curb.

The hooded section or stack cap is mounted on top of the roof curb. Extensions of the fan/damper section are available to insure clearance of the roof and structural ceiling supports.

Design Considerations

When applying a recirculating device such as the Three-Way or Two-Way Heat Saver/Ventilator, the installer should keep in mind terminal velocities for human comfort at floor levels. The recommended velocities for continuous exposure at work stations are:

- Sitting 74-125 ft/min.
- Standing 100-200 ft/min.

On buildings with low ceilings (20 to 30 ft. high), the installer should consider using an air distributor for

maximum employee comfort. Buildings with 40 to 50 ft. high ceilings can discharge downward through directional discharge grilles.

Relationship of Ceiling Height to Temp. Variance

ROOF ELEVATION	TEMPERATURE GRADIENT BETWEEN FLOOR AND CEILING
40 FT.	12° TO 20°F
30 FT.	8° TO 12°F
20 FT.	5° TO 8°F

Two-Way Heat Saver/Ventilator with Stack Cap (Model RRES)

A Two-Way Heat Saver unit is recommended when not all of the features of the Three-Way unit are required. The Two-Way Heat Saver unit has a lower first cost than the Three-Way design. It uses automatic (gravity) dampers rather than motor driven dampers, which have a lower first cost and require less maintenance than motorized dampers.

Application

Exhaust Mode – In the exhaust mode (Figure 4), the unit exhausts the heated air at the floor and ceiling levels to cool the working area.

During summer operation, where the work area is continually hot, a Two-Way Heat Saver/Ventilator is recommended (see Figure 4). In this configuration, the unit exhausts the warm ceiling air and the heated air from the floor to maintain a cool and comfortable working environment.

Recirculation Mode – In the recirculation mode (Figure 5), the unit recirculates warm air trapped near the ceiling and directs it to the floor level to save on heating costs.

Construction and Finish

Two-Way Heat Saver/Ventilators are manufactured from 12-gauge continuous welded steel. Units are finished with air-dry alkyd gray enamel.

Each unit is constructed with close tolerances between the propeller tips and the orifice to maintain maximum efficiency. The patented reversible, cast aluminum alloy fan wheel is secured to the motor shaft with a split taper lock bushing.

The Two-Way Heat Saver/Ventilator's rolled steel circular windband cuts down on wind resistance and is easily removable. Flanges are integrally formed for increased strength.

Figure 4. Exhaust Mode

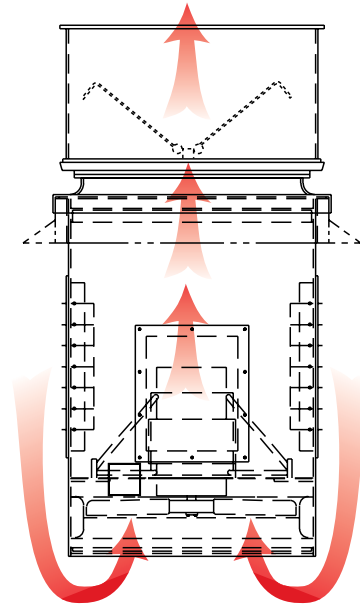
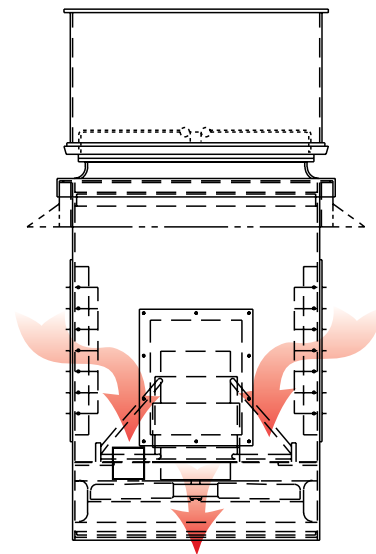

Figure 5. Recirculation Mode



Accessories

Disconnect Switch

Permits safe servicing of the unit. Designed to ensure isolation of the fan motor from remote starting equipment. Disconnect can be mounted and wired at the factory if the bolt-on flange accessory is also selected. Otherwise, disconnect must ship loose.

*NEMA 3R Enclosure
(rainproof/sleet
resistant)*



Discharge Grille

Permits the airflow to be directed in any downward direction and is recommended for buildings with 40 to 50 ft. high ceilings. The discharge grille features two sets of louvers operating in perpendicular directions. By adjusting one or both louvers, the downward airflow can be aimed to a specific location. The discharge grille mounts horizontally to the bottom of the fan/damper section.

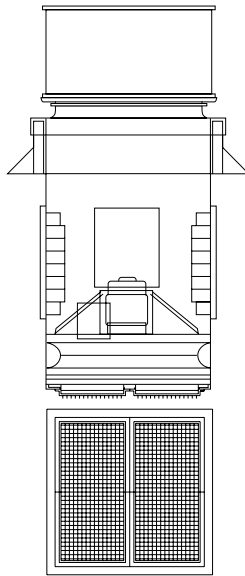

Air Distributor: 4-Way Directional Discharge Grille

Permits the airflow to be aimed horizontally in four directions and is recommended for buildings with low ceilings (20 to 30 ft.). One bi-directional grille is mounted vertically to each side of the fan/damper section to distribute the air in four directions.

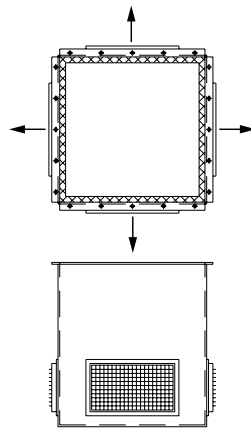

Bird Screen

Prevents foreign material from entering the fan assembly. On hooded units, a wire mesh type bird screen is mounted inside the plenum (not shown). On stack cap units, a spiral wire guard bird screen is bolted on top of the cap (shown below).



“L” Dimension Extension

Ensures the clearance of the roof and ceiling support structures. The square duct extension is available in 1-foot increments.

Bolt-On Flange

Permits the fan/damper section to be installed from inside the building from under the roof. The fan/damper section slides up through the roof opening. The flange is then bolted to the top of the fan/damper section and rests on the roof curb.

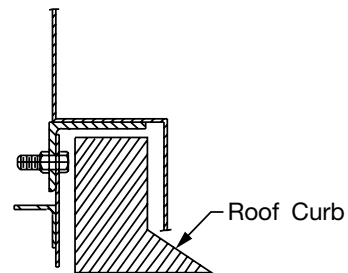

NEMA 4 Combination Reversing Starter/ Disconnect With Control Transformer

A reversing starter is used for changing the rotation of the motor and propeller. It permits the Three-Way Unit to switch from recirculating to exhaust or supply to exhaust (and vice versa).

The combination reversing starter simplifies field installation of the disconnect and starter by providing the two devices in a single enclosure. A separate disconnect switch is recommended above the roof for additional safety.

Control Station

Control Station & Enclosure

The control station consists of a 12-terminal terminal strip, 5-amp fuse, fuseblock, Supply-Off-Exhaust selector switch (reversing switch), remote set point, and nameplate overlay.

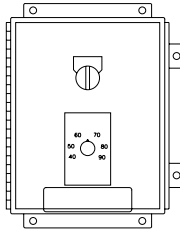

Components Mounted On Three-Way Heat Saver/Ventilator

1. Motor Operated Center-Pivoted Shutter

FAN SIZE	SHUTTER SIZE	
	SUPPLY/EXHAUST (QTY. 1)	RECIRCULATING (QTY. 2)
24	24 x 24	18 ³ / ₄ x 18 ³ / ₄
30	32 x 32	24 ³ / ₄ x 24 ³ / ₄
36	38 x 38	32 ³ / ₄ x 32 ³ / ₄
42	44 x 44	32 ³ / ₄ x 32 ³ / ₄
48	50 x 50	36 ³ / ₄ x 36 ³ / ₄
54	63 ³ / ₄ x 63 ³ / ₄	42 ³ / ₄ x 42 ³ / ₄
60	70 ³ / ₄ x 70 ³ / ₄	44 ³ / ₄ x 44 ³ / ₄

Dimensions are not to be used for construction.

2. Modulating Shutter Motor: Model M130 Johnson Controls. Torque Rating: 50 in-lb (5.6 n-m)
3. Shutter Motor Crankarm
4. Electronic Input Board — R81QAA
5. 24V Cover Mounted Transformer

Components Not Mounted On Three-Way Heat Saver/Ventilator

1. Discharge Sensor/Mounting Bracket
2. Remote Control Station

Three-Way Heat Saver Adjustment Procedure

1. Jumper terminal 8 to 10.
2. Apply 24VAC to terminals T1 and T2.
3. Adjust linkage to FULL CLOSED position on the outside air damper.
4. Turn power OFF and remove jumper.
5. Jumper 8 to T1.
6. Turn power ON.
7. Allow motor to travel until it stops; then turn “travel adjust” potentiometer to desired FULL OPEN position. **Caution:** M130 must not be allowed to stall; turn “travel adjust” potentiometer if necessary to prevent a stall condition.
8. Turn OFF power and remove jumper.
9. Connect system per wiring diagram.
10. Turn power ON.
11. Adjust the proportional band (blue knob labeled “PB adj”) midway between its full clockwise (CW) and full counterclockwise (CCW) rotation. This will give approximately a 15°F PB. If a smaller PB is desired turn CW. If actuator oscillates or hunts turn PB CCW until the system stabilizes.
12. Turn the M130 “Set Point” (black knob) full CCW.
13. Adjust remote set point (Y45) to desired setting.

Checkout Procedure

1. When installation and wiring are complete, make system settings and apply power.
2. Cycle the motor actuator, using the controller, after the linkage and motor actuator have been assembled to the valve or damper.
3. Observe at least three complete operating cycles to be sure that all components are functioning correctly.
4. The actuator should not be stalled by the damper or valve.
5. The actuator may be damaged if it is not free to complete its full stroke.

Repairs and Replacements

The drive motor and gear train are immersed in oil and sealed in a die-cast case; therefore, maintenance is not necessary.

Field repairs must NOT be made except for replacement of the cover or the R81 electronic board kits (ordered separately). For a replacement cover, motor actuator, or electronic board kit, contact the nearest Johnson Controls Commercial Systems wholesaler.

Three-Way Control Package Details

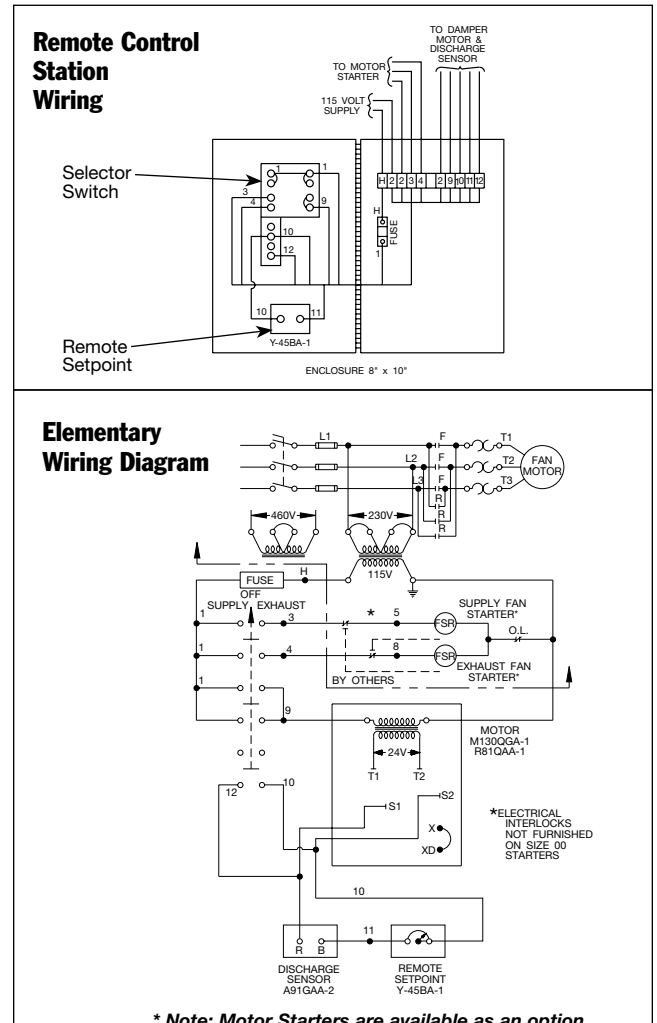

Dimensional Data

Three-Way Heat Saver/Ventilator – With Hooded Inlet and Motor Operated Dampers (Model RREH)

Note: Sizes 24 to 48 have fiberglass hoods.
 Sizes 54 & 60 have painted steel hoods.

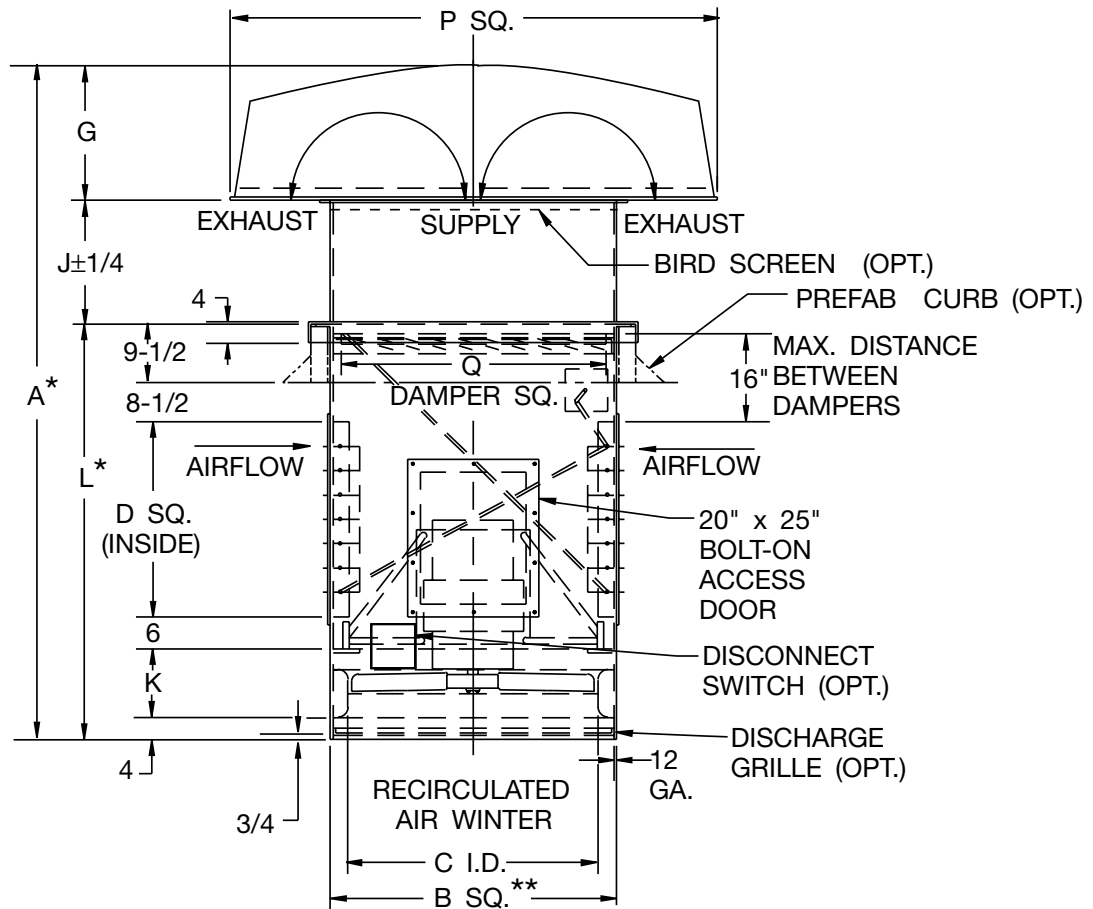

* Standard minimum length. Other lengths optional.

** Customer's minimum curb opening should be 1/4" greater than B sq. on this drawing.

'E' dimension is outside dimension of bolt-on flange. Consult factory for details.

Dimensions in inches unless otherwise noted.

Dimensions are not to be used for construction.

SIZE	A	B	C	D	E	G	J	K	L	P	Q
24	87 ³ / ₄	28 ¹ / ₄	24	18 ³ / ₄	34	15	17	9	55 ³ / ₄	56	24
30	96 ³ / ₈	36 ¹ / ₄	30	24 ³ / ₄	42	16 ¹ / ₂	17	10 ¹ / ₈	62 ⁷ / ₈	66	32
36	115 ¹ / ₁₆	42 ¹ / ₄	36	32 ³ / ₄	48	20	23	11 ¹⁵ / ₁₆	72 ¹ / ₁₆	76	38
42	123 ¹ / ₁₆	48 ³ / ₄	42	32 ³ / ₄	54	28	23	11 ¹⁵ / ₁₆	72 ¹ / ₁₆	98	44
48	128 ⁷ / ₈	54 ¹ / ₄	48	36 ³ / ₄	60	28	23	13 ¹ / ₈	77 ⁷ / ₈	98	50
54	131	68 ¹ / ₄	54	42 ³ / ₄	74	24	23	13 ¹ / ₄	84	120	63 ³ / ₄
60	138 ¹ / ₂	75 ¹ / ₄	60	44 ³ / ₄	81	24	23	16 ³ / ₄	89 ¹ / ₂	120	70 ³ / ₄

R29479B/R23659E

Dimensional Data

Two-Way Heat Saver/Ventilator — With Stack Cap and Automatic Recirculation Shutters (Model RRES)

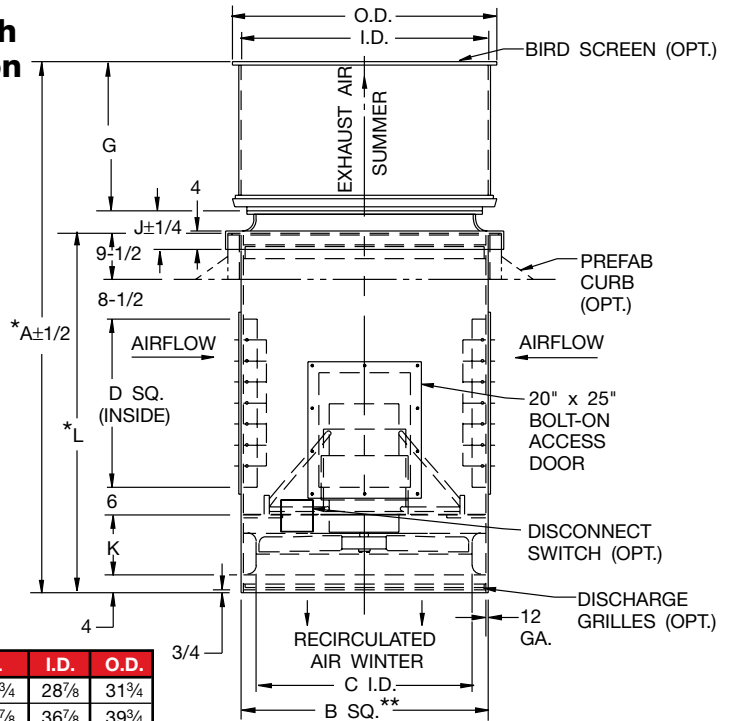

* Standard minimum length. Other lengths optional.
 ** Customer's minimum curb opening should be 1/4" greater than B sq. on this drawing.

'E' dimension is outside dimension of bolt-on flange. Consult factory for details.

Dimensions in inches unless otherwise noted.
 Dimensions are not to be used for construction.

SIZE	A	B	C	D	E	G	J	K	L	I.D.	O.D.
24	86 ⁷ / ₁₆	28 ¹ / ₄	24	18 ³ / ₄	34	24 ³ / ₄	10	9	55 ³ / ₄	28 ⁷ / ₈	31 ³ / ₄
30	97 ⁷ / ₁₆	36 ¹ / ₄	30	24 ³ / ₄	42	27 ³ / ₄	10 ⁷ / ₈	10 ¹ / ₈	62 ⁷ / ₈	36 ⁷ / ₈	39 ³ / ₄
36	110 ¹ / ₈	42 ¹ / ₄	36	32 ³ / ₄	48	30 ³ / ₄	10 ³ / ₄	11 ¹⁵ / ₁₆	72 ¹¹ / ₁₆	42 ⁷ / ₈	45 ³ / ₄
42	113 ³ / ₈	48 ¹ / ₄	42	32 ³ / ₄	54	33 ³ / ₄	11	11 ¹⁵ / ₁₆	72 ¹¹ / ₁₆	48 ⁷ / ₈	51 ³ / ₄
48	121 ¹³ / ₁₆	54 ¹ / ₄	48	36 ³ / ₄	60	36 ³ / ₄	11 ¹ / ₄	13 ¹ / ₈	77 ⁷ / ₈	54 ⁷ / ₈	57 ³ / ₄
54	136	68 ¹ / ₄	54	42 ³ / ₄	74	39 ³ / ₄	16 ¹ / ₄	13 ¹ / ₄	84	60 ³ / ₄	64
60	141 ¹ / ₂	75 ¹ / ₄	60	44 ³ / ₄	81	43 ³ / ₄	16 ¹ / ₄	16 ³ / ₄	89 ¹ / ₂	66 ³ / ₄	70

R23661E

Two-Way Heat Saver/Ventilator – With Hooded Inlet and Automatic Recirculation Shutters (Model RRES)

Note: Sizes 24 to 48 have fiberglass hoods.
 Sizes 54 & 60 have painted steel hoods.

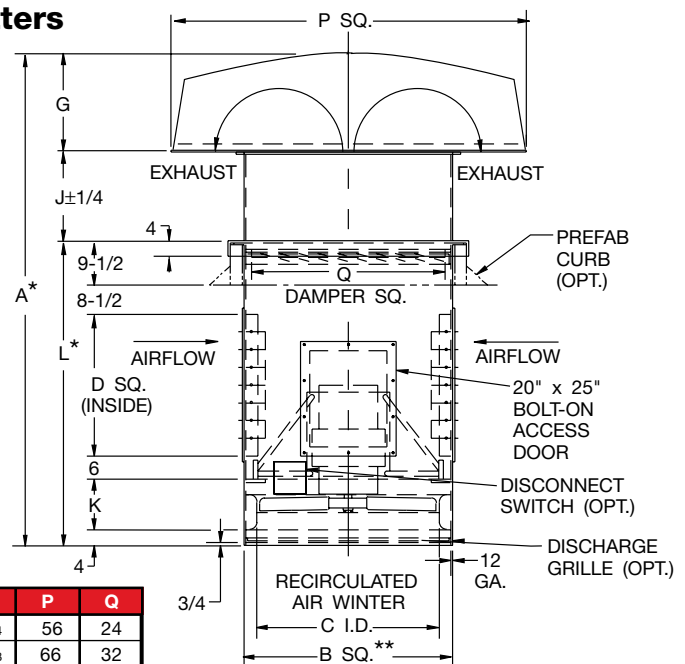

* Standard minimum length. Other lengths optional.
 ** Customer's minimum curb opening should be 1/4" greater than B sq. on this drawing.

'E' dimension is outside dimension of bolt-on flange. Consult factory for details.

Dimensions in inches unless otherwise noted.
 Dimensions are not to be used for construction.

SIZE	A	B	C	D	E	G	J	K	L	P	Q
24	87 ³ / ₄	28 ¹ / ₄	24	18 ³ / ₄	34	15	17	9	55 ³ / ₄	56	24
30	96 ³ / ₈	36 ¹ / ₄	30	24 ³ / ₄	42	16 ¹ / ₂	17	10 ¹ / ₈	62 ⁷ / ₈	66	32
36	115 ¹¹ / ₁₆	42 ¹ / ₄	36	32 ³ / ₄	48	20	23	11 ¹⁵ / ₁₆	72 ¹¹ / ₁₆	76	38
42	123 ¹ / ₁₆	48 ¹ / ₄	42	32 ³ / ₄	54	28	23	11 ¹⁵ / ₁₆	72 ¹¹ / ₁₆	98	44
48	128 ⁷ / ₈	54 ¹ / ₄	48	36 ³ / ₄	60	28	23	13 ¹ / ₈	77 ⁷ / ₈	98	50
54	131	68 ¹ / ₄	54	42 ³ / ₄	74	24	23	13 ¹ / ₄	84	120	63 ³ / ₄
60	138 ¹ / ₂	75 ¹ / ₄	60	44 ³ / ₄	81	24	23	16 ³ / ₄	89 ¹ / ₂	120	70 ³ / ₄

R29480B/R23660E

Performance Data

CATALOG NUMBER				CUBIC FT. PER MIN. & HORSEPOWER AT STATIC PRESSURE							
				0" SP		1/8" SP		1/4" SP		3/8" SP	
PROP	FAN TYPE*	RPM	HP	CFM	BHP	CFM	BHP	CFM	BHP	CFM	BHP
24R640	RRES	1160	3/4	6810	0.60	6140	0.66				
	RREH	1160	3/4	5960	0.68	5045	0.71				
24R628	RRES	1750	1	7020	0.69	6685	0.78	6320	0.87	5920	0.94
	RREH	1750	1	6645	0.79	6330	0.87	5975	0.93	5565	0.99
24R634	RRES	1750	1½	9285	1.23	8870	1.35	8430	1.46	7955	1.54
	RREH	1750	1½	8730	1.48	8325	1.53	7870	1.57	7360	1.63
30R630	RRES	1160	1	9680	0.84	9020	0.92	8265	1.01	7295	1.09
	RREH	1160	1	8950	0.96	8310	1.03	7475	1.08		
30R634	RRES	1160	1½	11660	1.15	10905	1.25	10050	1.35	9000	1.45
	RREH	1160	1½	10770	1.29	10035	1.37	9155	1.45		
30R640	RRES	1160	2	13820	1.79	13035	1.91	12045	2.03		
	RREH	1160	2	12900	1.96	12015	2.06	10625	2.13		
36R628	RRES	1160	2	15085	1.17	14405	1.35	13670	1.52	12880	1.69
	RREH	1160	2	14315	1.37	13655	1.52	12940	1.68	12170	1.83
36R632	RRES	1160	3	17670	1.82	17045	1.97	16360	2.13	15605	2.31
	RREH	1160	3	16990	2.00	16355	2.23	15670	2.45	14905	2.63
42R634	RRES	870	3	22650	1.95	21435	2.20	20185	2.45	18935	2.69
	RREH	870	3	21300	2.18	20190	2.40	19025	2.62	17850	2.84
48R626	RRES	870	3	24200	1.66	22945	1.94	21600	2.22	20165	2.49
	RREH	870	3	22815	2.06	21265	2.34	19560	2.63	17530	2.94
48R632	RRES	870	5	31450	3.12	30340	3.44	29135	3.77	27815	4.11
	RREH	870	5	30175	3.52	29030	3.87	27710	4.22	26060	4.59
54R626	RRES	870	5	34790	3.01	33380	3.42	31890	3.81	30315	4.20
	RREH	870	5	33245	3.46	31890	3.81	30460	4.17	28930	4.52
54R630	RRES	870	7½	42080	4.41	40635	4.94	39135	5.45	37570	5.94
	RREH	870	7½	40500	4.97	39135	5.45	37705	5.90	36190	6.34
54R634	RRES	870	10	49295	6.65	47760	7.21	46170	7.76	44520	8.31
	RREH	870	10	47685	7.25	46160	7.76	44590	8.26	42985	8.77
60R632	RRES	690	7½	49365	4.68	47590	5.17	45670	5.68	43565	6.22
	RREH	690	7½	48175	4.99	46430	5.49	44525	6.00	42415	6.52
60R636	RRES	690	10	56855	7.38	54450	8.08	51945	8.74	49345	9.35
	RREH	690	10	54195	8.16	51955	8.72	49590	9.28	47095	9.82
60R632	RRES	870	15	62245	9.38	60855	10.00	59400	10.63	57865	11.28
	RREH	870	15	60745	10.01	59375	10.64	57940	11.27	56420	11.91

* RRES - 2-Way Heat Saver/Ventilator

RREH - 3-Way Heat Saver/Ventilator

1. Performance shown is for installation Type A: free inlet, free outlet.
2. Performance ratings include the effects of either a hood (RREH) or a stack cap (RRES) in the airstream.

Typical Specifications

Heat Saver/Ventilators shall be direct drive Models RRES and RREH, as manufactured by Aerovent, Minneapolis, Minnesota, and shall be of the size and capacity as indicated in the fan schedule. Units shall be complete with:

- A Hood Assembly (RREH) for Vertical Supply and Discharge
- A Stack Cap Damper Assembly (RRES) for Vertical Upblast Discharge

Heat Saver/Ventilators shall be tested and certified with industry test codes and guaranteed by the manufacturer to deliver at the rated published performance levels. In addition, each unit shall be factory run tested prior to shipment.

CONSTRUCTION — The fan/damper section shall be constructed of 12-gauge mild steel and shall be continuously welded. The plenum houses a reversible, direct drive panel fan. The fan shall be constructed of the following optional metals:

- Aluminum
- Galvanized
- Stainless Steel 304
- Stainless Steel 316

PROPELLERS — Propellers shall be of cast aluminum alloy with reversible performance characteristics and shall be secured to the motor shaft with a split taper lock bushing on all sizes.

BALANCING — The propeller assembly shall be statically and dynamically balanced in accordance with ANSI/AMCA 204-96 "Balance Quality and Vibration Levels for Fans" to Fan Application Category BV-3, Balance Quality Grade G6.3. In addition, direct drive fan propellers shall be balanced on the motor shaft after final assembly in the fan, in the manufacturing facility, to the following peak velocity values, filter-in, at the fan test speed:

Fan Application Category	Rigidly Mounted (in./s)	Flexibly Mounted (in./s)
BV-3	0.15	0.20

MOTORS — Fan motors shall be foot mounted NEMA Design B, standard industrial continuous duty, ball bearing, variable torque type and shall be provided with the enclosure type, voltage, phase, and hertz as listed on the fan schedule.

FINISH — The units, after fabrication, shall be cleaned and chemically pretreated by a phosphatizing process and shall be painted inside and outside with an alkyd primer and finish painted with an air dry enamel.

SOUND POWER LEVELS — The sound power levels of the fan(s) shall not exceed

Octave Band-CPS (Sound Power 10^{-12})

63	125	250	500	1000	2000	4000	8000

OPTIONAL ACCESSORIES — The fans shall be furnished complete with:

- NEMA 3R Outdoor Rainproof Disconnect Switch — Mounted and Wired (Only for units that also have the bolt-on flange accessory. Shipped loose otherwise.)
- Discharge Grilles
- Air Distributor: 4-Way Directional Discharge Grille
- Square Flat Guard, Wire Mesh, Mounted in Top of Fan/Damper Section (RREH)
- Discharge Birdscreen, Mounted on Top of Stack Cap (RRES)
- "L" Dimension Extension
- Bolt-on Flange
- NEMA 4 Combination Reversing Starter/Disconnect With Control Transformer — IEC Starter or NEMA Starter (Shipped Loose).
- Prefabricated Insulated Roof Curb

Quality Air Handling Equipment

AXIAL FLOW



Tubeaxial

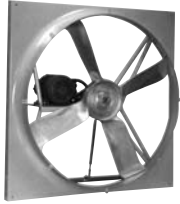

Panel Fan



Mancooler



Ring Fan



Tubeaxial Adjustable Pitch

VANEAXIAL



Type VT



Type W Adjustable Pitch



Type VTF Fiberglass



Type B Higher Pressure



Axico Anti-Stall

CENTRIFUGAL

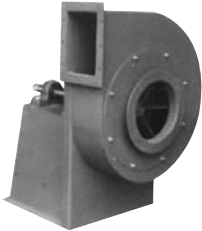

Industrial Exhaust



CB / CBA



Series 14 High Pressure



Centaxial



Pressure Blower

ROOF VENTILATOR



Upblast Propeller



Upblast Axial



Tu-WAY™

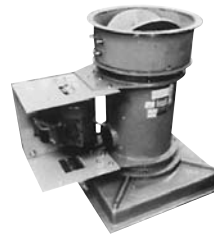

Fiberglass



PRV Centrifugal

AIR HEATER

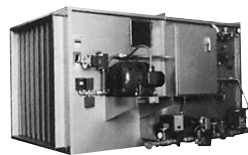

Gas-Fired Air Make-Up

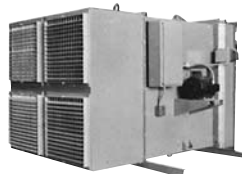

Steam Air Make-Up

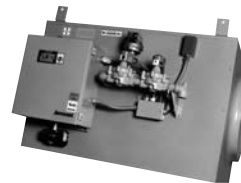

Door Air Heater

WARRANTY

Aerovent equipment is guaranteed to deliver its rated output, if properly installed and operated under normal conditions. Aerovent will correct by repair, replacement, or issuance of credit at our option, F.O.B. our plant, defects in material or workmanship which may develop under normal and proper use within eighteen (18) months after date of shipment from

our factory, if purchaser gives us notice within ten (10) days of discovering such defects. The correction of these defects by repair, replacement, or issuance of credit shall constitute fulfillment of all obligation to purchaser. (NOTE: We will not assume expense or liability for repairs made outside our factory without prior written consent.)



Aerovent

A Twin City Fan Company

5959 Trenton Lane · Minneapolis, MN 55442-3237

Phone (763) 551-7500 · Fax (763) 551-7501 · www.aerovent.com

1.5MPP12/09

